

Examples of Sensor Installation

The sensor is installed using a mounting band. Typically made of stainless steel it holds the sensor in place within a pipe or channel.

Spring loaded Band

This is the simplest of the mounting bands. The transducer is fixed to the band and the band is simply sprung loaded into a circular channel or small culvert.

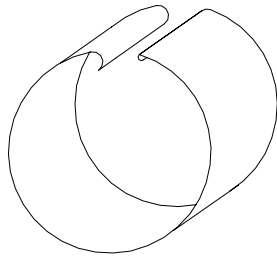

Scissor Jack band.

This is the same method as the spring loaded type band, but to give added support the scissor expander is used to firmly clamp the band in place.

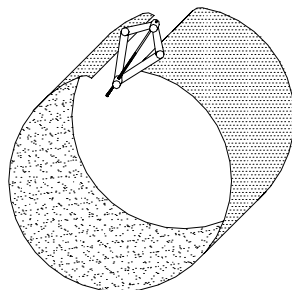

Rectangular Channel Sensor mount

This uses a scissor jack to place a force at one end of the band and securely fixing the other end of the band to produce an opposing force to ensure a firm grip is made against the channel walls.

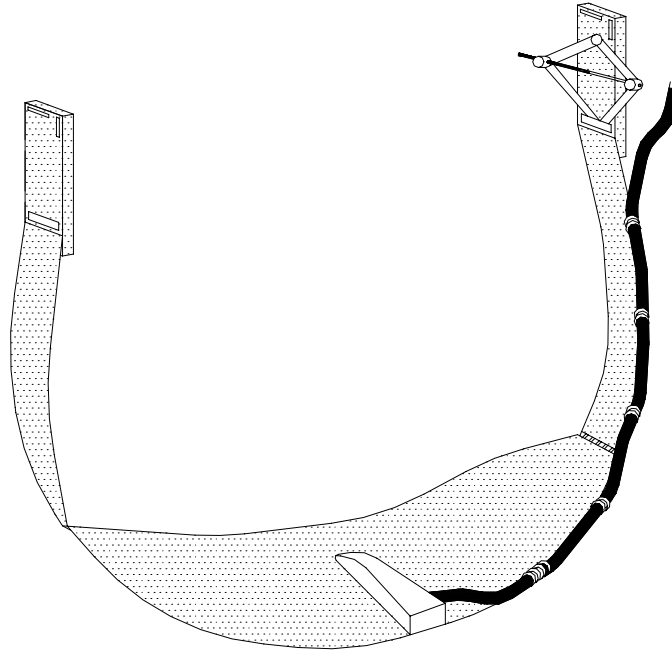

Where to install the sensor

This chapter contains application diagrams that show the best sensor location for a variety of typical installation sites.

Each diagram shows velocity profiles at several points. Places where the sensor should not be located and where the sensor may not be recommended to be installed but with a little information gathering may be installed as an alternative.

Outfall

Locate the sensor at least five times the pipe diameter (or Maximum level) from the outfall. The velocity profile becomes distorted closer to the outfall, making it difficult to obtain accurate measurements.

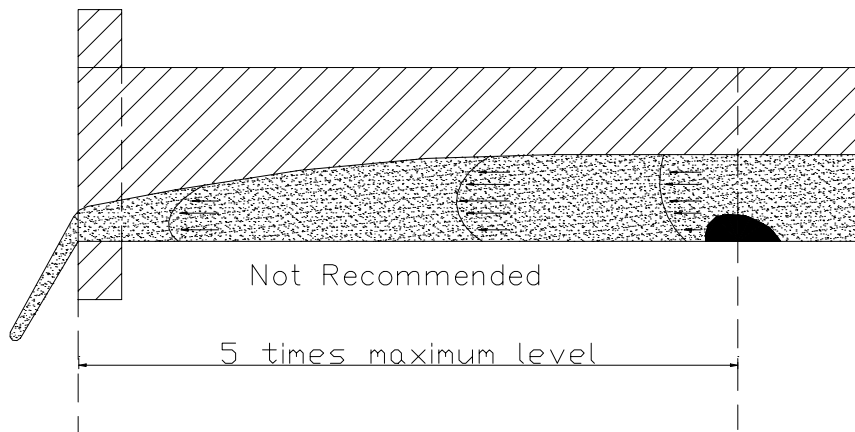

Low Flow – Dam

At least 30mm of water is needed for the sensor to make accurate velocity measurements. If the site frequently experiences low-flow conditions that may need to be monitored, a dam can be used to raise the level.

When the level is raised by this method the velocity profile will decrease. It is important to maintain a good balance between the two parameters and not raise the level too high that the velocity profiles fall too low. Recommended minimum velocity in this application is 50mm/sec.

It may also not be possible to use this method if the flow contains large amounts of sediment or rags etc. Again in situations like this the velocity needs to be kept high to aid self-cleaning.

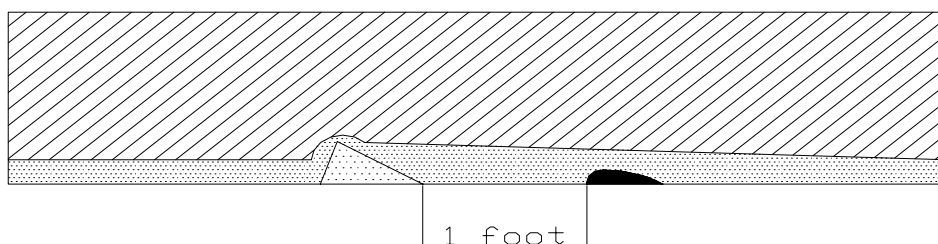

Vertical Drop or Baffle

The sensor should not be mounted near a vertical drop or baffle. Locate the sensor at least five times the pipe diameter (or maximum level) upstream from the vertical drop, or ten times the pipe diameter down stream. The same location criteria should be used for sites with a baffle or other obstruction in the channel.

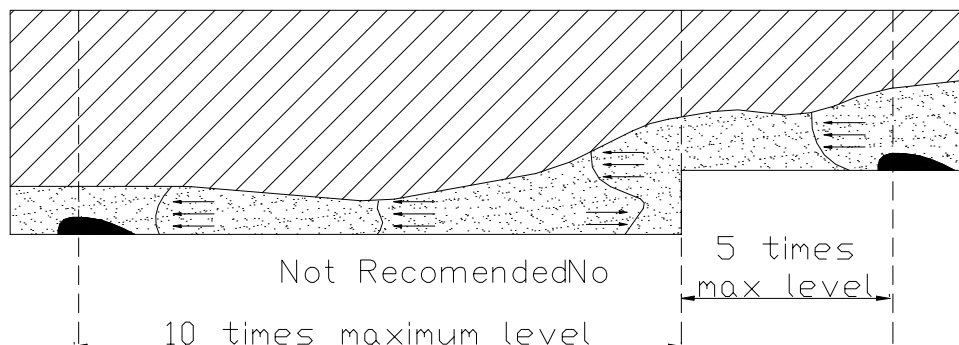

90 ° Elbow or gradual curve

If the sensor needs to be installed near a curve or elbow, it should be placed at least five times the pipe diameter (or maximum level) upstream, or ten times the pipe diameter down stream of the bend.

If these lengths are impossible it may be necessary to install a form of baffle to correct for turbulence and smooth out the velocity profile.

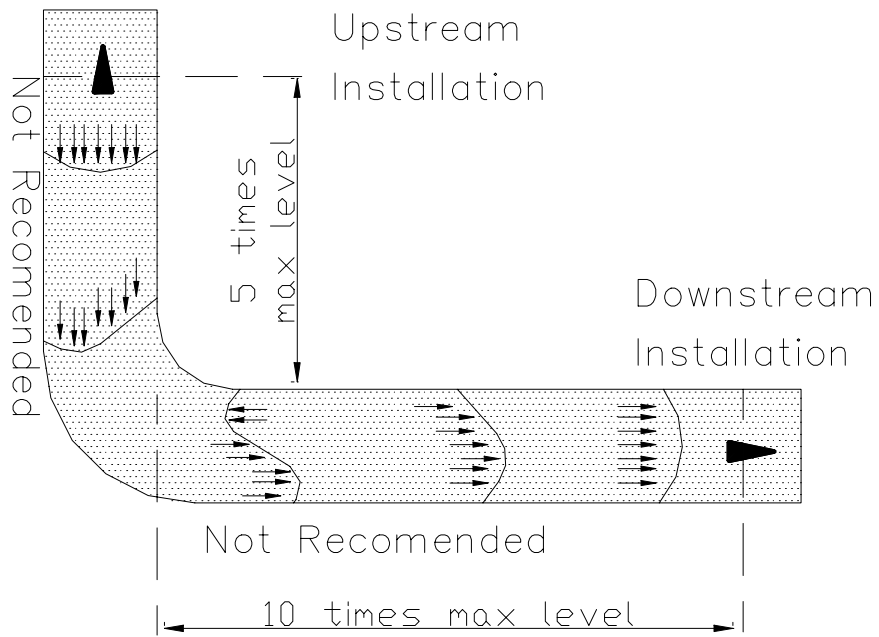

90 ° Pipe junction or Y junction

Locate the sensor away from any pipe junctions. The most ideal place is an entry point down stream, this is only possible however if one can be certain that no other entry points are met during the down stream pipe connection.

Place the sensor at least five times the pipe diameter (or maximum level) upstream, or ten times the pipe diameter downstream from the junction. If the flow from one junction is very high again a baffle may be installed to control the profile.

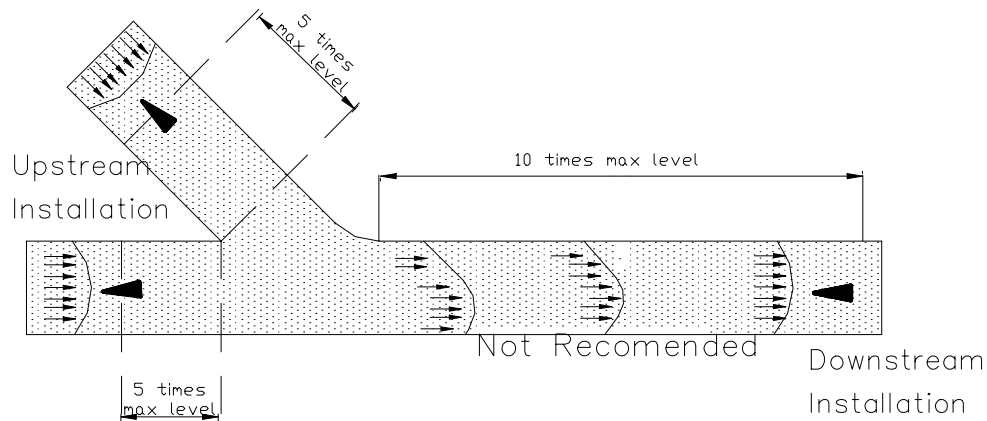

Installing the sensor

This chapter shows you how to assemble the sensor mounting equipment, as well as install the sensor at the site.

Spring Band

Parts list

- Mounting Band
- Open Channel Sensor
- Sensor Mounting Screws (2 – m3)
- Cable ties (approx 20)

Tools

- Flat head screw driver
- Wire Cutter

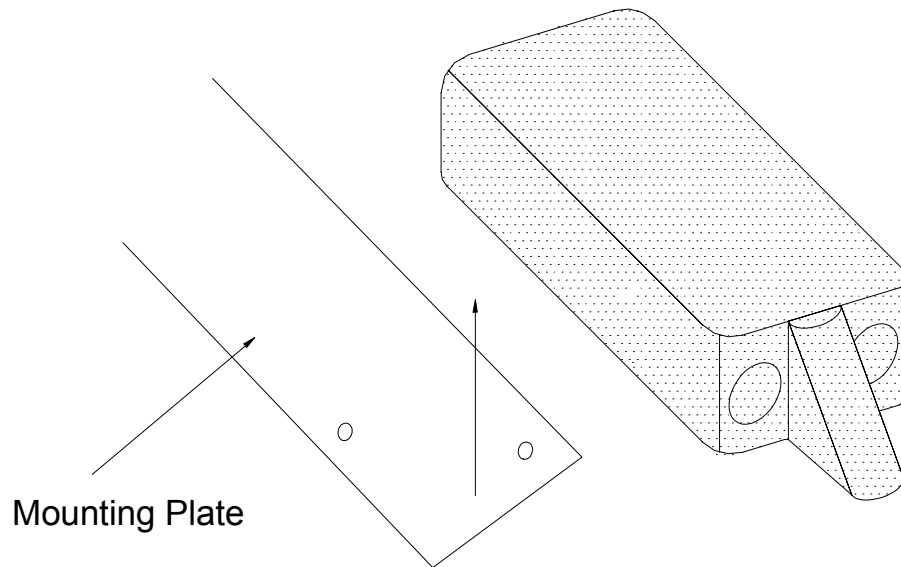

Attach the sensor to the band

1. Place the sensor on the bottom of the band
2. Place the sensor over the two screw holes and line the inserts up. Using the two m3 screws secure the sensor to the band

Secure the cable

1. Starting at the bottom near the sensor secure the sensor cable to the band with the cable ties. Running a cable tie through the pre-punched hole and around the cable does this.
2. Continue to cable tie the cable up the edge of the band and then cut off the extra cable tie lengths.

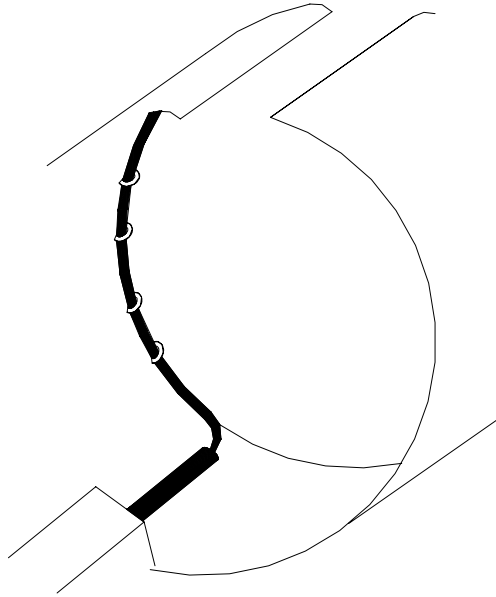

Insert the band

1. Squeeze the two open ends of the band together so that the band folds to a diameter smaller than the pipe it is to be inserted into. This can exercise can be made easier by clamping the two ends together using grip pliers.
2. Insert the band into the pipe front of the transducer facing upstream.
3. Release the grip pliers
4. Ensure the band fits the pipe wall flush

Scissor Jack Band

Parts list

- Mounting Band
- Open Channel Sensor
- Sensor Mounting Screws (2 – m3)
- Cable ties (approx 20)
- Scissor expanding Jack
- Split Pins (2)

Tools

- Flat head screw driver
- Wire Cutter

- Adjustable spanner

Assembling the band

1. Attach the sensor to the band as detailed before (Spring Band Installation)
2. Fit one pivot of the Scissor jack through one of the holes at the open end of the band. Then the other pivot through the hole on the opposite open end of the band.
3. Secure the pivots by fitting a split pin in the small hole situated on the side of each pivot.

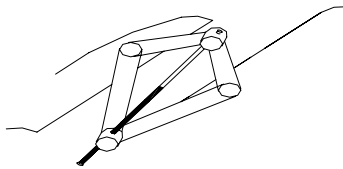

Installing the band and Scissor Jack

Rotate the scissor jack-securing nut anti clockwise to close hence reducing the diameter of the band.

Slide the band into the pipe and then rotate the scissor jack-securing nut clockwise. This begins to open the band increasing its diameter and will eventually securely clamp the band to the pipe wall.

Calculating Band lengths for scissor jacks

$\text{Pi} \times (\text{pipe Diameter}) - 50\text{mm} = \text{Band length required}$

Rectangular Channels

If your site has a rectangular channel, mounting of the sensor can be either by using a pole and plate system or scissor jack and band.

Pole and Plate

Parts

- Top Plate
- Pole
- Sensor Mounting Plate
- Sensor Mounting Screws
- Cable Ties
- 8mm through bolts (minimum 2)

Tools

- Flat head screw driver
- Wire Cutter

Assembling the Pole and Plate Mounts

1. Locate and drill at least two 8 mm diameter-mounting holes in the top plate
2. Anchor the top plate to the channel side using the 8mm through bolts
3. Attach the sensor to the bottom plate in the same way as mentioned previously for mounting band installations.
4. Fix the pole to the bottom and top plate and secure

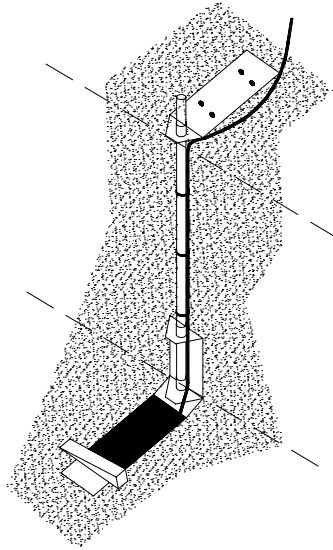

Band and Scissor Jack for Rectangular Channels

Parts list

- Mounting band
- Open Channel Sensor
- Sensor Mounting Screws (2 – m3)
- Cable ties (approx 20)
- Scissor expanding Jack
- Split Pins (2)
- 8mm Through Bolt (2)

Tools

- Flat head screw driver
- Wire Cutter
- Adjustable spanner

Assembling and fixing the band

1. Attach the sensor to the band as detailed before (Spring Band Installation)
2. Fit one pivot of the Scissor jack through one of the holes at the open end of the band.

3. Secure the pivot by fitting a split pin in the small hole situated on the side of the pivot.
4. Facing upstream Fix the opposite open end of the band to the left channel wall using a through bolt
5. Again facing upstream fix the other end of the scissor jack to the right hand channel wall with the second through bolt.
6. Rotate the scissor jack-securing nut clockwise to expand the band hence clamping it into the channel.

